

## Static strength evaluation of pipelines sections with crack-like defects in the weld zone

*Yu.V. Banakhevych*<sup>1\*</sup>, *R.Yu. Banakhevych*<sup>2</sup>, *A.V. Dragilev*<sup>3</sup>, *A.O. Kychma*<sup>4</sup>

<sup>1</sup> PJSC «UKRTRANSGAZ»;  
9/1, Klovsky uzviz, Kyiv, Ukraine

<sup>2</sup> MPD «Lvivtransgaz» PJSC «UKRTRANSGAZ»;  
3, I. Rubchaka Str., Lviv, Ukraine

<sup>3</sup> PE «Engineering Technologies»;  
60, Volynska Str., Kyiv, Ukraine

<sup>4</sup> National University "Lvivska politechnika";  
12, Stepan Bandera Str., Lviv, Ukraine

Received: 14.02.2014 Accepted: 04.12.2014

### Abstract

The article propounds the evaluation method of further life time of long-term used pipelines based on the definition of their safety coefficients with regard to the changes in geometry of crack-like defects and relaxed residual stresses. There are examined welding joints of pipe sections with the existing chisel-shaped defects that are modeled by external axial surface cracks. On the basis of the two-parametric criteria of ductile-brittle failure mechanics there are set criteria ratios of evaluation of their static strength.

There are obtained closed formulas for calculating safety coefficients of pipeline sections with cracks in welded joints considering variables along the pipe and beyond its residual stresses thickness. During the research we defined the residual stresses and their values averaged over the crack surface for specific pipeline sections with the external axial surface crack in the welded joint, calculated the stress intensity factor and informational stress  $\sigma_{ref}$ , which characterized the mechanism of ductile failure (plastic instability), and identified on this basis the safety coefficients. There are estimated the residual stresses influence on the static strength of pipeline section with the surface cracks in the weld and, according to regulatory documents, established categorization of their danger. There is made a research of the effect of thermoplastic deformation changes of pipe length and thickness on the level and distribution of residual stresses in the areas of circular weld zones of the pipe. The article analyzes the change of safety coefficient for different dimension ratios of external axial crack, placed in the weld.

The research of the actual conditions of pipelines operation, early recognition of actual sizes of chisel-shaped defects and calculation of safety coefficients of the MP sections with damages in accordance with the mentioned methodology allows experts of the production department to choose the technology and tools for the repair-and-renewal operations beforehand, taking into account the mode of transportation and supply of oil and gas to consumers, minimizing the potential risks of accidents.

*Key words: defects, failure, failure assessment diagram, oil and gas pipelines, safety coefficient, static strength, stress, welding joint.*

In recent years, technological disasters of pipelines characterized the industrialized world, as evidenced by the global experience of pipeline systems operation. Thus, in Alberta (Canada) a brittle failure of the gas pipeline at a speed of crack propagation 100...300 m/s took place in 2001 due to corrosion damage of the welding joint and the weld proximity. This resulted in a pipe fracture in a 100 m lot and forming of an earthen crater with the diameter of 90 meters and the depth of

8 m. Losses from the accident amounted to several million dollars. Pipeline transport accidents of similar nature and with no less losses occurred not long ago in USA [1], Canada [2], Russia [3], Ukraine [4] and other countries of Europe, Asia, Africa, etc.

The above examples illustrate the urgent problem of prevention a catastrophic failure of critical long-term operation facilities, such as oil and gas pipelines. The analysis of accident damages on the pipeline transport shows that there are changed mechanical properties of steels under the long-term operation of pipelines influenced by the cyclic loads [5], corrosive environments [6], and the running temperatures variation [7]. This leads to brittle fracture with the design loads, even without any visible signs of damage [8].

\* Corresponding author:  
banakhevich-yv@utg.ua

Geometric heterogeneity, especially in the form of chisel-shaped defects of slit-shaped type, can significantly affect the strength and lifetime of pipelines. Therefore, one of the main problems of modern technical diagnosis is identification and measuring such defects, their shapes and sizes without destroying the integrity of the pipe body. To solve this problem there were elaborated the appropriate means of control based on the results of the research in different countries [9]. Complexes for the interiorly tubular diagnosing of the defects in the pipe body should be, in particular, allocated among them [10].

The problems of fracture mechanics of pipeline sections with crack-like defects in the weld zones and pipe parent metal are widely described in the literature. For example, the experts from Karpenko Physico-Mechanical Institute of the NAS of Ukraine offered a computed model [11] of pipe body limit-equilibrium state with a crack on triaxial static and cyclic load. Accounting of a geometrical nonlinearity in calculating the thin-wall elastic pipes with long axial cracks are studied in [12]. Analytical approaches for determining the local (in the area of defects) and global stress state of pipelines generally are described in the monograph [13]. However, the analysis of the known studies shows that they do not take into account the effect of residual stresses in the welded joints on the static strength of pipeline sections with crack-like defects.

**Criteria relation of static strength evaluation of pipelines sections with crack-like defects such as cracks in the weld zone.** For evaluation the strength of the pipeline with such defects as cracks we use the Failure Assessment Diagram (FAD), which is a limiting curve that defines the limit strength between safe and unsafe state of the construction and allows the simultaneous analysis of two marginal states – brittle and ductile. This diagram is based on two-parametric criteria of ductile-brittle failure [14]

$$Y = f(k L_r) - k K_r, \quad (1)$$

where  $K_r = K_1/K_{1c}$  is a dimensionless stress intensity factor (SIF), which characterizes the mechanism of brittle failure in the corresponding area along the crack periphery;  $K_{1c}$  is a critical score of the SIF;  $L_r = \sigma_{ref}/\sigma_T$  is a parameter that defines a mechanism of ductile failure (plastic instability) for this crack;  $k$  is a permitted safety coefficient that is controlled by regulations.

Function  $f(k L_r)$  is given in literary sources on the basis of numerous experimental data for different materials and can be represented as [15]

$$f(k L_r) = (1 - 0.14k^2 L_r^2) \left[ 0.3 + 0.7 \exp(-0.65k^6 L_r^6) \right], \quad (2)$$

for  $L_r \leq L_r^{\max}$  and  $f(k L_r) = 0$  for  $L_r > L_r^{\max}$ , where

$$L_r^{\max} = \frac{\sigma_B + \sigma_T}{2\sigma_T} \text{ for most pipe steels, } \sigma_B \text{ is the material}$$

limit strength in the crack zone.

It is also recommended to build the failure assessment diagram (FAD) in the coordinates  $K_r$  and  $S_r = \sigma_{ref}/\sigma_B$  ( $\sigma_B$  – the limit strength of the material), and the function  $K_r = f(S_r)$ , which characterizes the margin line, can be approximated by the following formulas:

$$\begin{cases} K_r = 1, & 0 \leq S_r < 0.7\sigma_T/\sigma_B; \\ K_r = \frac{1}{1 - 0.7\sigma_T/\sigma_B} \left( 1 - \frac{0.21\sigma_T}{\sigma_B} - 0.7S_r \right), & \frac{0.7\sigma_T}{\sigma_B} \leq S_r < 1; \\ S_r = 1, & 0 \leq K_r < 0.3. \end{cases} \quad (3)$$

This diagram and the categorization fields of defects are shown in Fig. 1. The green color in this figure highlights the admissible domain, which is obtained by decrease of limitary portion by  $k$  times based on the criterion of static strength. The defects are divided into three conditional categories depending on the level of safety coefficient: minor, dangerous (moderate, major) and critical.

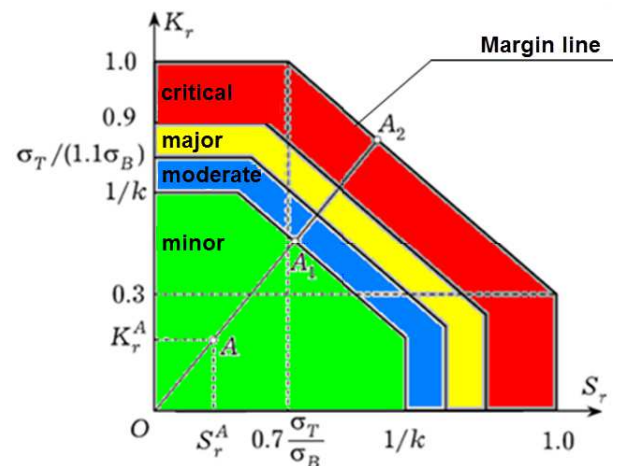

$S_r$  is a dimensionless coefficient that characterizes the degree of approximation to the ductile failure;  $K_r$  is a dimensionless stress intensity coefficient that characterizes the mechanism of a brittle failure;  $\sigma_B$  is a limit strength;  $\sigma_T$  is a limit of liquidity;  $k$  is a permitted safety coefficient

**Figure 1 – The diagram of the failure assessment and the field categorization**

The SIF  $K_1$  and  $\sigma_{ref}$  are calculated for the state of stress that influences the pipe section; according to the given factors we calculate the point grid reference  $A$ , which determines the strength of the pipeline with a crack on a two-criteria diagram:

$$K_r^A = \frac{K_1}{K_{1c}}, \quad S_r^A = \frac{\sigma_{ref}}{\sigma_B}. \quad (4)$$

The safety coefficient  $n$  for the given computational point  $A$  is graphically calculated by the ratio of segments:

$$n = \frac{OA_2}{OA}, \quad (5)$$

where  $A_2$  is an intercept of the ray OA with the limit curve of FAD. The safety coefficient  $n$  can also be calculated analytically by the relationship:

$$n = \frac{S_r^{A_2}}{S_r^A} \quad \text{or} \quad n = \frac{K_r^{A_2}}{K_r^A}. \quad (6)$$

Based on the expressions (3), (5) for calculation a safety coefficient  $n$  we obtain the following formulas:

$$n = \frac{1}{K_r}, \quad 0 \leq S_r < \frac{0.7\sigma_T}{\sigma_B};$$

$$n = \frac{1-0.21\sigma_T/\sigma_B}{(1-0.7\sigma_T/\sigma_B)K_r + 0.7S_r}, \quad \frac{0.7\sigma_T}{\sigma_B} \leq S_r < 1;$$

$$n = \frac{1}{S_r}, \quad 0 \leq K_r < 0.3. \quad (7)$$

Depending on the numerical value of the safety coefficient  $n$  according to the regulatory document [14] the pipe section with a defect by the criterion of the static strength shall be interpreted as:

operative, and the defect absolutely acceptable if  $n \geq k$ . The defect is classified as a minor defect (light area in Fig.1);

conditionally inoperative, and the defect is conditionally unacceptable if the safety coefficient is within  $2k/(1+k) \leq n < k$ . The defect is classified as a dangerous defect. To make a decision on terms of repair measures, this category of defects is divided into two parts: moderate defect, if  $1.1\sigma_B/\sigma_T \leq n \leq k$  and major defect, if  $1.1 \leq n \leq 1.1\sigma_B/\sigma_T$ ;

inoperative, and the defect is absolutely unacceptable if  $n < 1.1$ . The defect is classified as a critical defect.

Admissible safety coefficient by the criterion of the static strength is calculated by the formula [14, 16]:

$$k = \frac{0.9k_n k_p}{m}, \quad (8)$$

where  $k_n$  is a partial safety coefficient for material strength;  $k_p$  is an intended safety coefficient;  $m$  is the coefficient of the working conditions. Safety coefficients are determined by the SNIP 2.05.06–85 [16].

In cases where a crack is in effective area of residual stresses, the stress intensity coefficient is represented as a sum of:

$$K_1 = K_1^H + K_1^{res}, \quad (9)$$

$K_1^H$  is determined by an external loading, and  $K_1^{res}$  – by residual stresses. Then, respectively,

$$K_r = K_r^H + K_r^{res}. \quad (10)$$

It should be noted that the residual welding stresses almost completely have time to relax before the forming of plastic instability and do not affect the value of  $\sigma_{ref}$ . Consequently, when calculating the parameter  $S_r$ , residual stresses are not recommended to be taken

into account. Therefore the formulas for calculating the safety factor  $n$  (7) are represented in the following form

$$n = \frac{1}{(1+\zeta^r)K_r^H}, \quad 0 \leq S_r < \frac{0.7\sigma_T}{\sigma_B};$$

$$n = \frac{1-0.21\sigma_T/\sigma_B}{(1-0.7\sigma_T/\sigma_B)(1+\zeta^r)K_r^H + 0.7S_r},$$

$$\frac{0.7\sigma_T}{\sigma_B} \leq S_r < 1; \quad (11)$$

$$n = \frac{1}{S_r}, \quad 0 \leq K_r < 0.3,$$

where  $\zeta^r = K_r^{res}/K_r^H$ .

**Practical results.** Based on the formulas (11) for welded pipe joints made of steel 17G1S ( $\sigma_B = 510$  MPa,  $\sigma_T = 326$  MPa) there are made numerical computing and assessment of the effect of residual stresses on the dependence of the safety coefficient  $n$ , which corresponds to the summary action of the operating and residual stresses, to the safety coefficient  $n_p$  without considering the residual stresses ( $\zeta^r = 0$ ). The graph in Fig. 2 shows the dependence of the coefficients ratio  $n/n_p$  of the value of  $S_r^A$  for different values of  $\zeta^r$  and the dimensionless SIF  $K_r^H = 0.4$ .

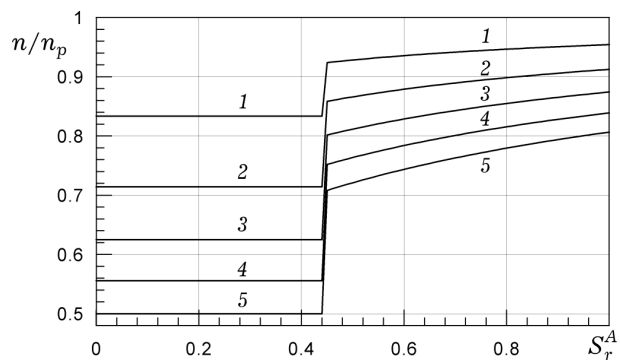

$n$  is the safety coefficient that corresponds to the summary action of the operating and residual stresses;  $n_p$  is the safety coefficient without considering residual stresses;  $S_r^A$  is a dimensionless coefficient that characterizes the degree of approximation to the ductile failure at point A;  $\zeta^r = K_r^{res}/K_r^H$  is the coefficient that takes into account the ratio of SIF from residual stresses  $K_1^{res}$ , to the SIF from external loadings  $K_1^H$ ; 1 –  $\zeta^r = 0.2$ ; 2 – 0.4; 3 – 0.6; 4 – 0.8; 5 – 1.0

**Figure 2 – The influence of residual stresses on variables  $n/n_p$  depending on  $S_r^A$  for different values  $\zeta^r$**

The analysis of the graphs shows that if the values  $S_r^A$  rise, the influence of residual stresses decreases, and if the values  $\zeta^r$  rise, the influence of residual stresses increases.

In case of  $S_r^A < 0.65$  the influence of residual stresses is seen at  $\zeta^r = 0.2$ . After high-temperature tempering of welding joints, as it is mentioned in works [17], unrelaxed residual stresses in the weld zone remain at the level of 50–120 MPa, and under operational loads that cause the operating voltage stresses of 250–300 MPa, the residual stresses are to be taken into account when assessing the fatigue life of welding joints.

**Evaluation of residual stresses influence on the strength of pipe sections with welding joints with axial surface cracks in the weld zone.** The authors studied the evaluation method of the residual stresses influence on the strength and the forecasting of residual life of gas pipeline with axial surface cracks in the weld zone.

We examine the straight pipeline section influenced by the action of internal pressure  $p$  with welding joint with the external surface defect in the annular field weld modeled by a direct-axis superficial semi-elliptically shaped crack with semi-axes  $a$  and  $c$  in circular cylinder according to the regulations (Fig. 3).

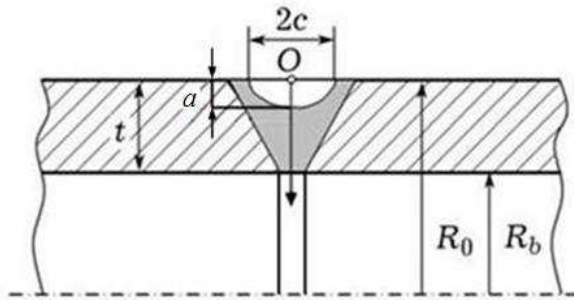

*a and c are the semi-axes of a semi-elliptically shaped crack; t is the pipe thickness; R<sub>0</sub> is the outer radius of a pipe; R<sub>b</sub> is the internal radius of a pipe; O is the origin of coordinates*

**Figure 3 – The fourth pipe section with an external axial semi-elliptically shaped crack**

The position of an arbitrary point on the crack periphery is defined by the angle  $0 \leq \varphi \leq \pi$  (Fig. 4). If the angle  $\varphi = 0$ , the point on the crack periphery is located on the surface, and if  $\varphi = \pi/2$ , the point is located on the crack periphery, which corresponds to its maximum depth.

For calculating the stress  $\sigma_{ref}$  the authors use the recommendations of the relevant literature. In case when a pipeline section with an axial superficial semi-elliptically shaped crack is under the action of internal pressure  $p$ , the calculation expression for  $\sigma_{ref}$  can be written as

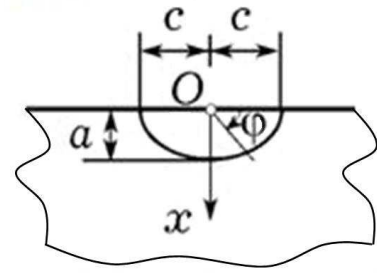

*a and c are semi-axes of a semi-elliptically shaped crack; x is a direction of axis;  $\varphi$  is the angle that defines the location of a point on the crack periphery; O is the origin of coordinates*

**Figure 4 – Geometrical parameters of an axial semi-elliptically shaped crack**

$$\sigma_{ref} = \frac{g\sigma_b + [(g\sigma_b)^2 + 9(M_s\sigma_m)^2]^{0.5}}{3} \quad (12)$$

Here

$$g = 1 - 20 \left( \frac{a}{2c} \right)^{0.75} \alpha^3, \quad \alpha = \frac{a}{t} \frac{1}{1 + \frac{t}{c}}$$

$$M_s = \frac{1}{1 - 0.85 \frac{a}{t}} \left[ 1 - 0.85 \frac{a}{t} \left( \frac{1}{M_t} \right) \right],$$

$$M_t = \left( \frac{1.02 + 0.4411\lambda^2 + 0.006124\lambda^4}{1.0 + 0.02642\lambda^2 + 1.533 \cdot 10^{-6} \lambda^4} \right)^{0.5},$$

$$\lambda = \frac{1.818 c}{\sqrt{R_b t}}, \quad (13)$$

$R_b$  is the internal radius of pipe;  $\sigma_m, \sigma_b$  are the stresses normal to the crack edge membrane and the bending [15],

$$\sigma_m = \frac{PR_b}{t},$$

$$\sigma_b = \frac{PR_0^2}{R_0^2 - R_b^2} \left[ \frac{t}{R_b} - \frac{3}{2} \left( \frac{t}{R_b} \right)^2 + \frac{9}{5} \left( \frac{t}{R_b} \right)^3 - 2 \left( \frac{t}{R_b} \right)^4 \right], \quad (14)$$

where  $R_0$  is the outer radius of the pipe.

**The theoretical results.** There is made a numerical analysis of the problem for the pipe section of the gas pipeline made of steel graded X60 ( $E = 2 \cdot 10^5$  MPa,  $\mu = 0,3$ ,  $\sigma_B = 588$  MPa,  $\sigma_T = 440$  MPa), with diameter  $D = 1020$  mm and wall thickness  $t = 21$  mm, which is subjected to internal pressure  $p = 4.5$  MPa. The calculation is carried out for external axial semi-elliptically shaped crack in a welding joint at different depths  $a$  with the ratio of semi-axes of ellipse  $c = 1.2a$  and circular residual stresses  $\sigma_{\beta\beta}^{*r}$ , averaged over the crack surface.

Stress intensity factor  $K_I^H$  for the external axial surface crack in the pipe due to internal pressure  $p$  is calculated by the following formula:

$$K_1^H = \frac{\rho R_b^2}{R_0^2 - R_b^2} \left[ 2G_0 + 2G_1 \left( \frac{a}{R_b} \right) + 3G_2 \left( \frac{a}{R_b} \right)^2 + 4G_3 \left( \frac{a}{R_b} \right)^3 + 5G_4 \left( \frac{a}{R_b} \right)^4 \right] \sqrt{\frac{\pi a}{Q}} \quad (15)$$

The distribution of residual stresses in the weld zone is described by the formulas:

$$\sigma_{\beta\beta}^r(\alpha, x) = \sigma_0^r + \sigma_1^r \left( \frac{x}{t} \right) + \sigma_2^r \left( \frac{x}{t} \right)^2 \quad (16)$$

Here

$$\begin{aligned} \sigma_0^r(\alpha) &= \hat{W}(\alpha) + \mu \left[ \hat{\sigma}_{\alpha 0}(\alpha) - \frac{2}{3} \hat{\sigma}_{\alpha 1}(\alpha) \right] + \\ &+ (1 + q_1 - n_1) \varphi_1(\alpha) S_1^0(\alpha); \\ \sigma_1^r(\alpha) &= -2 \left\{ \mu \left[ \hat{\sigma}_{\alpha 0}(\alpha) - 2 \hat{\sigma}_{\alpha 1}(\alpha) \right] + \right. \\ &+ (q_1 - 2n_1) \varphi_1(\alpha) S_1^0(\alpha) \left. \right\}; \\ \sigma_2^r(\alpha) &= -4 \left[ \mu \hat{\sigma}_{\alpha 1}(\alpha) + n_1 \varphi_1(\alpha) S_1^0(\alpha) \right]; \quad (17) \end{aligned}$$

$$\begin{aligned} \hat{\sigma}_{\alpha 0}(\alpha) &= \frac{\lambda}{2(1-\mu^2)} \left\{ -\sqrt{3(1-\mu^2)} \left( 1 - \frac{n_1}{3} \right) F_{21}(\alpha) + \right. \\ &+ \mu q_1 F_{11}(\alpha) + K q_2 \left[ F_{12}(\alpha) - \rho F_{13}(\alpha) \right] \left. \right\}; \\ \hat{\sigma}_{\alpha 1}(\alpha) &= \frac{\lambda}{1-\mu^2} \left\{ \mu n_1 \varphi_1(\alpha) S_1^0(\alpha) + \right. \\ &+ K n_2 \left[ \varphi_2(\alpha) S_2^0(\alpha) - \rho \varphi_3(\alpha) S_3^0(\alpha) \right] \left. \right\}. \end{aligned}$$

The calculation of residual stresses in the studied welding joint have to be performed for the distribution of thermoplastic deformations under the following values of numerical parameters:  $k_1 = 0.7$  ( $E_1^* = k_1 \sigma_T / E$ );  $k = 0.1$ ;  $s_1 = 1$ ;  $s_2 = 2$ ;  $\rho = 0.8$ ;  $n_1 = 0.5$ ;  $n_2 = 0.6$ ;  $q_1 = 0.25$ ;  $q_2 = 0.3$ ;  $b_1 = 12$  mm;  $b_2 = 9$  mm;  $b_3 = 6$  mm.

The graph in Fig. 5 shows the distribution of residual stress  $\sigma_{\beta\beta}^r$  on the outer (solid line), internal (dotted line) and median (dash-dotted line) surfaces of the pipe.

Stress distribution  $\sigma_{\beta\beta}^r$  through the pipe thickness in sections  $z = 0$  and  $z = 4.0$  mm is graphically depicted in Fig. 6.

The expression for calculating the averaged over the surface external semi-elliptical crack (Fig. 3)  $\sigma_{\beta\beta}^{*r}$  can be written as

$$\begin{aligned} \sigma_{\beta\beta}^{*r} &= \frac{4}{\pi \alpha_*^2} \int_0^{\alpha_*} \sqrt{\alpha_*^2 - \alpha^2} \left[ \sigma_0^r(\alpha) + \right. \\ &+ \frac{1}{2\alpha_*} \left( \frac{a}{t} \right) \sqrt{\alpha_*^2 - \alpha^2} \sigma_1^r(\alpha) + \frac{1}{3\alpha_*^2} \left( \frac{a}{t} \right)^2 (\alpha_*^2 - \alpha^2) \sigma_2^r(\alpha) \left. \right] d\alpha, \end{aligned} \quad (18)$$

where  $\alpha_* = c/R$ .

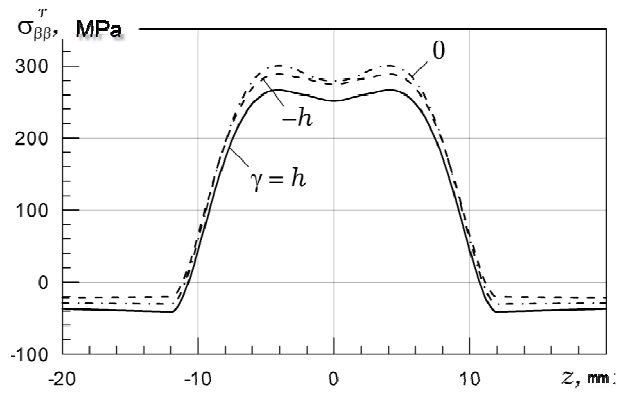

$\gamma = h$  on the pipeline outer surface;  
 $\gamma = -h$  on the pipeline inner surface;  
 $\gamma = 0$  on the pipeline median surface

**Figure 5 – The dependence of circular residual stresses  $\sigma_{\beta\beta}^r$  in circular welding joint on the distance  $z$  along the axis of the pipe**

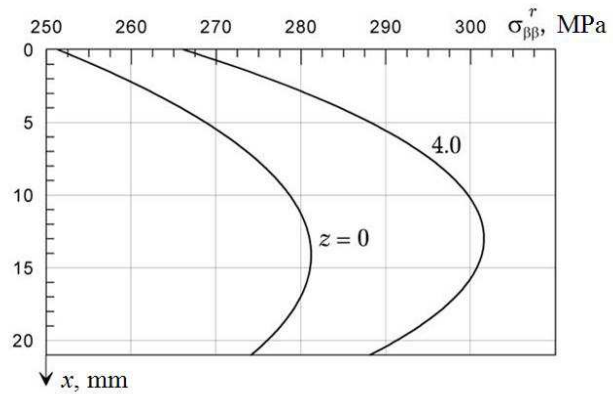

$z = 0$  is distribution of residual stresses on the line of symmetry of the joint;  $z = 4.0$  mm is stress distribution at a distance of 4.0 mm from the line of symmetry of the joint

**Figure 6 – The dependence of circular residual stresses on the distance  $x$  from the outer surface of the pipe**

In case of the residual stress distribution, shown in Fig. 5,  $\sigma_{\beta\beta}^{*r} = 261$  MPa.

For the above values of stresses and ratios of geometrical dimensions of the crack at different depths there are calculated the values of  $K_1$  and  $\sigma_{ref}$ , caused by the action of total stresses from internal pressure  $\sigma_{\beta\beta}^p$  and residual stresses  $\sigma_{\beta\beta}^{*r}$  ( $\sigma_{\beta\beta} = \sigma_{\beta\beta}^p + \sigma_{\beta\beta}^{*r}$ ) and correspondingly  $K_r = K_1 / K_{1C}$  and  $S_r = \sigma_{ref} / \sigma_B$ , according to the given recommendations [15]. According to the experimental data in [14] the value of  $K_{1C}$  is  $K_{1C}^m = 48 \text{ MPa} \cdot \sqrt{m}$  for the welding material. Then there are calculated safety coefficients of welding joint  $n$  according to formulas (11) and safety coefficients  $n_p$ , which correspond to the influence of the

operating stresses on the pipe section with a crack in the welding joint  $\sigma_{\beta\beta}^H = p \frac{R_b}{t} (\tilde{\sigma}_{\beta\beta}^{*r} = 0)$ .

Fig. 7 shows the dependence of safety coefficients  $n$  and  $n_p$  on the relative depth of the crack  $a/t$ .

Straight line  $n=1.63$  corresponds to the level of acceptable safety coefficient  $k$  by the criteria of the static strength, which is  $k=1.63$  according to the normative document [14] for this pipeline section. The line  $n=1.1$  corresponds to the limit; the safety coefficients below it have values according to which the relevant defects are classified as critical. Curve 1 characterizes the dependence of the safety coefficient  $n_p$ , which corresponds to the level of operating stresses  $\sigma_{\beta\beta}^H = 104.8$  MPa. Curve 2 shows the dependence of the safety coefficient  $n$  on the crack depth with regard to the summary action of operating stresses  $\sigma_{\beta\beta}^H$  and residual stresses  $\sigma_{\beta\beta}^{*r} = 100$  MPa, which remain in the weld zone even after high-temperature tempering. Curve 3 is built with regard to operating and averaged residual stresses  $\sigma_{\beta\beta}^{*r} = 261$  MPa.

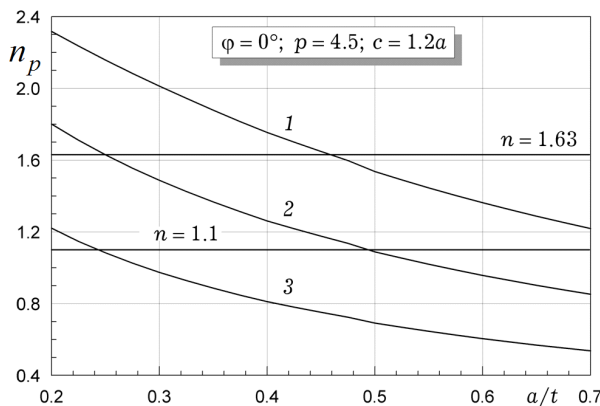

$a$   $i$   $c$  are semi-axes of a semi-elliptically shaped crack;  
 $n$  is a safety coefficient that corresponds to the summary action of operating and residual stresses;  
 $p$  is the pressure in MPa;  $t$  is the pipe thickness;

$\phi$  is the angle that defines the location of a point on the crack periphery; 1 is characterizes the dependence of the safety coefficient  $n_p$  on the action of the operating load; 2 is shows the dependence of the safety coefficient  $n$  on the crack depth with regard to the summary action of operating and residual stresses; 3 is a characteristic curve, built with regard to operating and averaged residual stresses

**Figure 7 – The dependence of safety coefficients  $n$  (curves 2, 3) and  $n_p$  (curve 1) on the relative depth of the crack  $a/t$**

The graphs show that the value of safety coefficient  $n$  of a defective welding joint is substantially reduced with increasing of the crack depth. Besides, residual stresses have a significant impact, and

a critical value of a safety coefficient reaches  $n=1.1$  at the defect depth  $a/t = 0.49$  if  $\sigma_{\beta\beta}^{*r} = 100$  MPa.

The outlined approach can be used for pipes after their prolonged operation, which leads to the change of mechanical and physical properties of steels [6], and also for the distribution of residual stresses.

**Conclusions**

Based on the two-parametric criteria of ductile-brittle failure and failure assessment diagram, regulated by the normative documents, we obtained the closed formulas for calculating the safety coefficients of pipeline sections with external axial cracks in the welding joints with regard to the variables along the pipe and beyond its residual stresses thickness.

These characteristic curves for the pipe, made of steel X60, with outer diameter of 1020 mm, show that when the dimensionless factor increases it characterizes the approximation measure to the ductile failure  $S_r$ , the effect of residual stresses on the change of the ratio of safety coefficient  $n$ , which corresponds to the summary action of the operating and residual stresses, to safety coefficient  $n_p$ , without consideration of the residual stresses, reduces, and when the relative coefficient of residual stresses  $\zeta^r$  grows the effect increases. If  $S_r^A < 0.65$  the influence of residual stresses becomes apparent at  $\zeta^r = 0.2$ .

The value of safety coefficient  $n$  of a defective welding joint substantially reduces when the crack depth increases. Meanwhile the residual stresses have an important impact: when  $\sigma_{\beta\beta}^{*r} = 100$  MPa the critical value of the safety coefficient reaches  $n=1.1$  at the defect depth  $a/t = 0.49$ .

**References**

[1] Trench, C.J. 2003, “The U.S. Oil Pipeline Industry’s Safety Performance”, Report for Association of Pipelines and American Petroleum Institute’s Pipeline Committee, 40 p.  
 [2] Corrosion Cracking / An industry leading document detailing the management of transgranular SCC, 2<sup>nd</sup> Edition. CEPA Canadian Energy Pipeline Association, December 2007, Calgary, Canada, 130 p.  
 [3] Medvedev V.N., Kuznetsov V.V., Shapiro V.D., etc. On the causes of the accident pipes of main gas pipelines: Collected papers from Research and Practice Seminar. [Steel aging problems of main pipelines], (Nizhniy Novgorod, January 23-25, 2006) / NIFTI Lobachevsky State University of Nizhni Novgorod. Novgorod, FPK MELAKS Publ., 2006, pp.110–122.  
 [4] Rybakov, A.A. 2012, “The research on pipelines failures caused by crack-like defects of technological origin in welded pipes”, A Collection of Papers: Improving the Reliability and Efficiency of the Linear Part of the Gas Pipelines of the Gas Transportation System, Yaremche, pp. 68–79.  
 [5] Banakhevych, Yu, Andreykiv, O. & Kit, M 2009, “Prediction of residual pipeline resource taking into account the operation loading conditions”, Strength of Materials, no. 1 (397), pp. 44–52.

- [6] Kryzhanivskiy, Ye.I. & Nykyforchyn, G.M. 2011, "Specific features of hydrogen-induced corrosion degradation of steels of gas and oil pipelines and oil storage reservoirs", *Physical and Chemical Mechanics of Materials*, V. 47, no. 2, pp. 127–138.
- [7] Kyrian, V.I., Osadchuk, V.A. & Nykolyshyn, M.M. 2007, "Fracture mechanics of welding joints of steel structures", Lviv: Spolom, 320 p.
- [8] Makhnenko, V.I. 2006, "The resource of a safe operation of welding joints and connections of contemporary constructions", Kyiv, 618 p.
- [9] Lobanov, L.M., Pivtorak, V.A., Savickii, V.A. & Tkachuk, G.I. 2006, "The methodology for determining residual stresses in welding joints and structural elements using speckle interferometry", *Automatic Welding*, no.1, pp. 25–30.
- [10] Kondratiev, D.V. 2011, "The software for the defects revealed during the ITD of the linear part of Pipelines according to the criteria", *A Collection of Papers: Improving the Reliability and Efficiency of the Linear Part of the Gas Pipelines of Gas Transportation System*, Yaremche, pp. 48–51.
- [11] Ivanytskyi Ya.L. & Kun P.S. Crack resistance of structural materials under multiaxial loading. Lviv, SPOLOM Publ., 2013, 280 p.
- [12] Orynyak I. & Rozgonyuk V. Accounting of geometrical nonlinearity in calculating the thin-wall elastic pipes with long axial cracks. *Machine science*, 2006, № 1, pp. 3–10.
- [13] *Strength of Materials and Structures: A Series of monographs* (General edition by V. T. Troshchenko), Kyiv, G.S. Pisarenko Institute for Problems of Strength, NAS of Ukraine, Vol. 4. *Strength analysis of the pipeline with defects* / I. V. Orynyak. – 2011. – 472 p.
- [14] *State Standard of Ukraine 2.3-21, 2008, "Main Pipelines. Guidelines. Determination of Residual Strength of Pipelines with Defects"*, *The order of the Ministry of Regional Development № 376 of 20.08.2008*, Kyiv, 88 p.
- [15] API 579. *Fitness-For-Service, API Recommended Practice 579, First Edition*, American Petroleum Institute, 2000. – 625 p.
- [16] *Building Regulations: Design Standards of Pipelines*, 2.05.06-85, 1985, Moscow, 62 p.
- [17] Makhnenko, V.I. 2004, "Improvement of methods for assessing the residual life of welding joints in structures with a long operation lifetime", *A Collection of Major Publications of the Department "Mathematical Methods of Studying the Physical and Chemical Processes in Welding and Special Electrometallurgy" of E.O. Paton Electric Welding Institute of the NAS*, pp. 3–12.

УДК 622.691

## Оцінка статичної міцності ділянок трубопроводів з тріщиноподібними дефектами в зоні зварного шва

Ю.В.Банахевич<sup>1\*</sup>, Р.Ю. Банахевич<sup>2</sup>, А.В. Драгилев<sup>3</sup>, А.О. Кичма<sup>4</sup>

<sup>1</sup> ПАТ «Укртрансгаз»; 9/1, Кловський узвіз, Київ, Україна

<sup>2</sup> УМГ «Львівтрансгаз» ПАТ «Укртрансгаз»; 3, вул. І. Рубчака, Львів, Україна

<sup>3</sup> ПП «Інжинірингові технології»; 60, вул. Волинська, Київ, Україна

<sup>4</sup> Національний університет "Львівська політехніка"; 12, вул. С. Бандери, Львів, Україна

Запропоновано методику оцінки ресурсу трубопроводів тривалої експлуатації на основі визначення їх коефіцієнтів запасу міцності з урахуванням зміни геометрії тріщиноподібних дефектів і релаксованих залишкових напружень. Розглянуто зварні з'єднання ділянок трубопроводів з наявними гострокінцевими дефектами, що моделюються зовнішніми осьовими поверхневими тріщинами. На основі двопараметричного критерію механіки крихко-в'язкового руйнування встановлено критеріальні співвідношення оцінки їх статичної міцності.

Одержано замкнуті формули для обчислення коефіцієнтів запасу міцності ділянок трубопроводів з тріщинами у зварних з'єднаннях з урахуванням змінних уздовж труби і за її товщиною залишкових напружень. Для конкретних ділянок трубопроводу із зовнішньою осьовою поверхневою тріщиною у зварному з'єднанні визначено залишкові напруження і їх усереднені по поверхнях тріщин значення, обчислено коефіцієнт інтенсивності напружень та довідкове напруження  $\sigma_{ref}$ , що характеризують механізм в'язкого руйнування (пластичну нестійкість), і на цій основі визначено коефіцієнти запасу міцності. Оцінено вплив залишкових напружень на статичну міцність ділянки трубопроводу з поверхневими тріщинами у зварному шві і, згідно з нормативними документами, встановлено категорійність їх небезпеки. Досліджено вплив зміни термопластичних деформацій за довжиною і товщиною труб на рівень і розподіл залишкових напружень у зонах кільцевих зварних швів трубопроводів. Проаналізовано зміну коефіцієнта запасу міцності для різних співвідношень розмірів зовнішньої осьової тріщини, розміщеної у зварному шві.

Вивчення реальних умов експлуатації магістральних трубопроводів, та своєчасне виявлення параметрів дефектів дає можливість згідно наведеної методології оцінити вплив геометричних розмірів і місць розташування гострокінцевих дефектів, з урахуванням змінних вздовж труби і за її товщиною залишкових напружень, на коефіцієнт запасу міцності ділянок магістральних трубопроводів, зводячи до мінімуму можливі ризики виникнення аварійних ситуацій.

Ключові слова: газові і нафтові трубопроводи, дефекти, діаграма оцінки руйнування, зварний шов, коефіцієнт запасу міцності, напруження, руйнування, статична міцність.